



# Edger "E" System



**Owners Manual and Safety Instructions**

# Table of Contents

## Important Information

Introduction .....1  
Service Information .....1  
Special Safety Information .....1

## Safety and Warnings

Safety Decals .....2  
General Safety Rules .....3

Assembly Instructions .....6

Operation .....9

Maintenance .....10

Warranties Policy .....Back Cover

## Important Information

### A. Introduction

This attachment is fitted with a blade, intended to be used to edge flower beds, sidewalks, driveways, curbs, etc.

### B. Specification.

MODEL	SHAFT LENGTH	TOTAL WEIGHT
330103	24.5"	7.2 lbs.

### C. Contents of the package

1. Edge Trimmer Attachment Assembly
2. Handle with handle bracket
3. Wheel assembly with bracket
4. Blade shield with debris flapper
5. Blade

### D. Service Information Contact

If you have questions about any topic in this Manual, or for the name of your local dealer, call 1-800-366-6268 toll free, Monday - Friday, 8:00 a.m. to 5:30 p.m., Eastern Time, or ask for Customer Service.

### E. Special Safety Information

**▲ WARNING ▲ DANGER ▲**  
**ATTENTION: THIS SYMBOL POINTS OUT  
IMPORTANT SAFETY INSTRUCTIONS**  
**▲ WHEN YOU SEE THIS SYMBOL ▲**  
**HEED ITS WARNING! STAY ALERT!**

**▲ WARNING ▲ DANGER ▲**  
**READ & UNDERSTAND THIS MANUAL BEFORE  
ATTEMPTING TO OPERATE THIS MACHINE.**  
**TO REDUCE THE POTENTIAL FOR ACCIDENTS,  
COMPLY WITH THE SAFETY INSTRUCTIONS IN  
THIS MANUAL. FAILURE TO COMPLY MAY RESULT  
IN SERIOUS PERSONAL INJURY AND OR  
EQUIPMENT AND PROPERTY DAMAGE.**

# Safety and Warnings

## A. Safety Decals

Please pay particular attention to the warning and information decals found on various parts of this Edger Attachment unit. They are an important part of the safety system. These decals must be replaced in time due to abrasion, etc. It is your responsibility to replace the decals when they become hard to read. The location of these decals and their part numbers for ordering are shown below.

**⚠ WARNING - DANGER ⚠**

**IMPROPER USE OR CARE OF THIS EDGER, OR FAILURE TO WEAR PROPER PROTECTION CAN RESULT IN SERIOUS INJURY.**

**READ AND UNDERSTAND THE RULES FOR SAFE OPERATION AND ALL INSTRUCTIONS IN THIS MANUAL.**

**WEAR EYE AND HEARING PROTECTION, AND PROPER CLOTHING.**

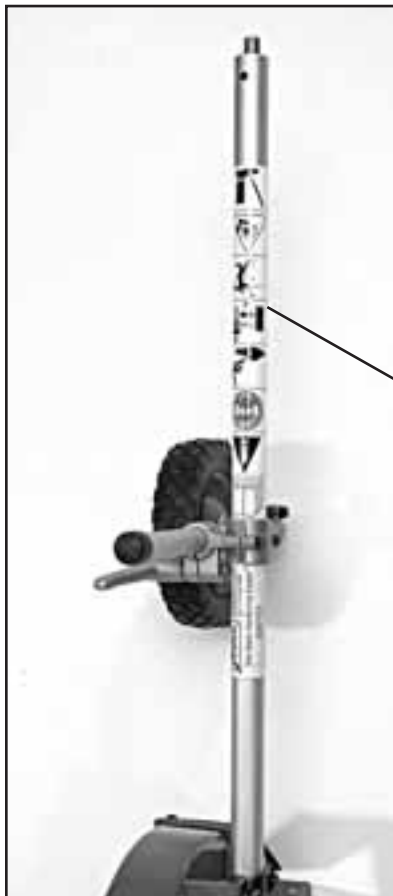

READ AND UNDERSTAND OPERATOR'S MANUAL BEFORE USING!

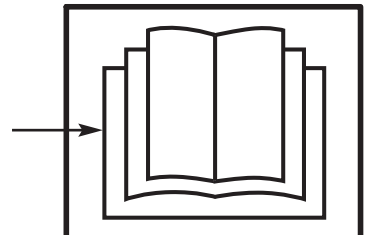

WARNING!

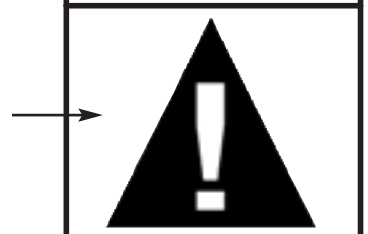

WARNING! WEAR EYE AND EAR PROTECTION



WARNING! WEAR SLIP-RESISTANT FOOTWEAR. MAINTAIN FOOTING AND BALANCE AT ALL TIMES.



**DO NOT STAND ON SLIPPERY, UNEVEN OR UNSTABLE SURFACES. DO NOT WORK IN ODD POSITIONS OR ON A LADDER. DO NOT OVER REACH.**

KEEP BYSTANDERS AT A SAFE DISTANCE. DANGER ZONE SURROUNDING THE OPERATOR. ONLY THE OPERATOR SHOULD BE IN THE DANGER ZONE!

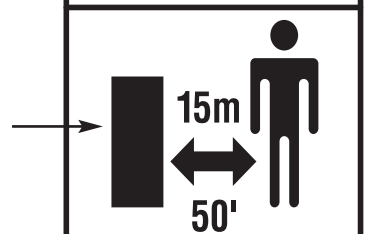

WARNING! THROWN OBJECTS!

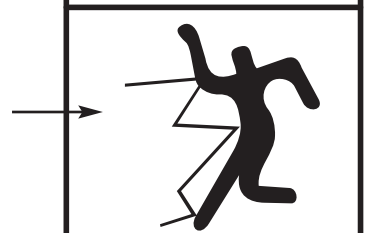

WARNING! ROTATING CUTTING BLADE!



DANGER! CUTTING HAZARD! KEEP FEET AWAY FROM ROTATING BLADES!

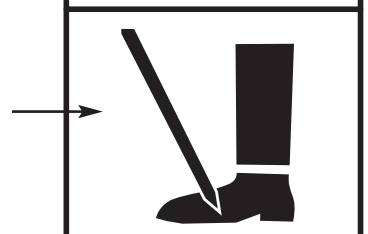

P/N 331180

## General Safety Rules

1. Never edge while people, especially children or pets are nearby.
2. Before using, always visually inspect to see that the blade, blade bolts and cutter assembly are not worn or damaged.
3. Do not start the motor when a bystander is standing in front of the blade.
4. Do not put hands or feet near or under rotating parts.
5. Never lean over the rotating cutting head. Rocks or other debris could be thrown into eyes and face and cause serious personal injury.
6. Use extreme caution when reversing or pulling the edger toward you
7. Make sure the blade has stopped before crossing surfaces other than grass and when transporting the edger to and from the area to be edged.
8. Never operate the edger with defective, missing or incorrectly fitted guards.

**⚠ WARNING ⚠**  
**WHEN USING ELECTRIC TOOLS, BASIC SAFETY PRECAUTIONS, INCLUDING THE FOLLOWING, SHOULD ALWAYS BE FOLLOWED TO REDUCE THE RISK OF FIRE, ELECTRIC SHOCK AND PERSONAL INJURY.**

Pay particular attention to all sections regarding safety.

Read and understand all these instructions before operating this product and save these instructions. Be familiar with the controls and the proper use of equipment.

### For safe operations:

1. Keep work area clean.  
Cluttered areas and benches invite injuries.
2. Consider work area environment.  
Do not expose power tools to rain. Do not use power tools in damp or wet locations. Keep work area well lit. Do not use power tools where there is risk of fire or explosion.
3. Guard against electric shock.  
Avoid body contact with earthed or grounded surfaces, e.g. pipes, radiators, stoves, ovens, refrigerators.
4. Keep children away.  
Do not let visitors touch the tool or extension cord. All visitors should be kept away from area. Local regulations may restrict the age of the operator.

5. Store idle tools.  
When not in use, tools should be stored in a dry, high or locked up place, out of reach of children.
6. Do not force the tool.  
It will do the job better and safer at the rate for which it was intended. Walk, never run.
7. Use the right tool.  
Do not force small tools or attachments to do the job of a heavy duty tool. Do not use tools for purposes not intended; for example, do not use chain saw attachment to cut tree limbs or logs.
8. Dress properly.  
Do not wear loose clothing or jewelry that can be caught in moving parts. Long trousers, non-slip gloves and sturdy work shoes with non-skid soles are recommended when working outdoors. Wear protective hair covering to contain long hair.
9. Use protective equipment.  
To avoid injury, wear ear, eye protection, face or dust mask if the operation is dusty. To avoid injury from falling branches, wear helmet. Eye protection must meet ANSI Z 87.1 requirements.
10. Do not abuse the cord.  
Never carry the tool by the cord or yank it to disconnect it from the socket. Keep the cord away from heat, oil and sharp edges.
11. Maintain tool with care.  
Keep cutting tools sharp and clean for better and safer performance. Follow instructions for lubrication and changing accessories. Inspect tool cord periodically and if damaged, have it repaired by an authorized service facility. Inspect extension cords periodically and replace, if damaged. Keep handles dry, clean and free from oil and grease.
12. Disconnect tools.  
When not in use, before servicing and when changing accessories such as blades, bits and cutters.
13. Remove adjusting keys and wrenches.  
Form the habit of checking to see that keys and adjusting wrenches are removed from the tool before turning it on.
14. Avoid unintentional starting.  
Do not carry a plugged in tool with a finger on the switch trigger. Ensure switch is off when plugging in.
15. Use outdoor extension leads.  
When tool is used outdoors, use only extension cords intended for outdoor use.
16. Important extension cord information:
  - a. Make sure the extension cords are in good condition before use.

- b. Based on the total length of cord that you are going to use, check the chart to make sure the cord meets the correct minimum cord gauge (AWG) requirements.

**IMPORTANT NOTE:**

Using an undersized cord or a larger number cord gauge (AWG) than recommended in the chart, will cause a loss in power and overheating of the unit. Using a smaller number cord gauge (AWG) than recommended in the chart, is acceptable.

**Extension cord chart** (minimum cord gauge (AWG))

Length (feet)	1 to 25	26 to 50	51 to 100	101 to 150
Cord gauge (AWG)	18	16	14	12

- 17. **Stay alert.**  
Watch what you are doing. Use common sense. Do not operate tool when you are tired, ill or under the influence of alcohol or other drugs.
- 18. **Check damaged parts.**  
Before further use of the tool, a guard or other part that is damaged should be carefully checked to determine that it will operate properly and perform its intended function. Check for alignment of moving parts, free running of moving parts, breakage of parts, mounting and any other conditions that may affect its operation. A guard or other part that is damaged should be properly repaired or replaced by an authorized service center unless otherwise indicated in this instruction manual. Have defective switches replaced by an authorized service facility. Do not use the tool if the switch does not turn it on and off.  
**Don't** operate the machine with a damaged or excessively worn cutting device.
- 19. The use of any accessory or attachment, other than those recommended in this instruction manual, may present a risk of personal injury.
- 20. **Have your tool repaired by a qualified person.**  
This electric tool conforms to relevant safety requirements. Repairs should only be carried out by qualified persons using original spare parts, otherwise this may result in considerable danger to the user.
- 21. Keep in mind that the operator or user is responsible for accidents or hazards occurring to other people or their property.
- 22. Work only in daylight or in good artificial light.
- 23. Keep all guards attached at all times when unit is operated.
- 24. **Always use the shoulder strap.**  
Adjust the strap for comfort before starting the engine.
- 25. **Secure unit during transport** to prevent damage or injury.
- 26. **Machine should not be used in any position that causes any part to come within 10 feet of overhead electrical lines.** Always be aware of overhead power lines.
- 27. **Always** keep a firm grip on both handles when motor is running: one hand grasps the front "loop" handle while the other hand grasps the rear handle. Severe injuries can result if you try to use this machine with only one hand or with an insecure grip.
- 28. **Thoroughly** inspect the area where equipment is to be used and removed all objects, which can be thrown by the machine.
- 29. **Always** keep area clear of children, pets, and bystanders.
- 30. **Always** inspect your unit before each use and ensure that all handles, guards and fasteners are secure, operating, and in place. Be sure that all electrical cords are not damaged or broken.
- 31. **Always** maintain and examine your attachments with care. Follow maintenance instructions given in manual.
- 32. **Don't** attempt to repair any part of the extended reach "E" system. Have repairs made by a qualified repairman. See that only original "Mantis" parts are used.
- 33. Maintain a firm footing and good balance, do not overreach while trimming. Before you start to trim, check the work area for obstacles that might cause you to lose your footing, balance or control of the machine. While operating the machine always be sure of a safe and secure operating position especially when using steps or a ladder. Always be sure of your footing on slopes.

**⚠ WARNING – DANGER ⚠**

**LITTLE WONDER WILL NOT BE RESPONSIBLE FOR THE FAILURE OF CUTTING DEVICES OR ACCESSORIES THAT HAVE NOT BEEN TESTED AND APPROVED FOR USE WITH THIS UNIT. USE ONLY MANUFACTURER-RECOMMENDED REPLACEMENT PARTS.**

**⚠ WARNING – DANGER ⚠**

**IMPROPER ASSEMBLY OF THIS EQUIPMENT  
CAN RESULT IN SERIOUS INJURY. MAKE SURE  
TO FOLLOW ALL INSTRUCTIONS CAREFULLY.  
IF YOU HAVE ANY QUESTIONS, CONTACT  
MANTIS CUSTOMER SERVICE.**

34. Always disconnect power cord from power source:
- Before cleaning blockages.
  - Before checking, cleaning or working on the cutting portion of the unit.
  - After striking a foreign object: inspect the cutting part for damage and make repairs before restarting and operating the unit.
  - If machine starts to vibrate abnormally (check immediately).
  - Whenever you leave the unit.

35. Securing the extension cord.  
Bend the extension cord about 15 inches from the plug end. Push that bend through the oblong opening in the back of the handle. Then loop the bend under the cord retaining clips as shown. This will prevent the extension cord from detaching from the hedge trimmer plug.



## Assembling the Edge Trimmer

Tools:  $\frac{9}{16}$ " wrench, pin supplied with the unit or screwdriver

1. Remove the following parts from the Edge Trimmer Assembly: blade mounting bolt #1 by rotating it clockwise, clamping plate #2, gear case cover #3, holding screws #4, and cover #5. (Pictures 1 and 2)
2. Install the blade guard to the gear case aligning 3 mounting holes (Picture 4), then put on cover #5, align all holes and install 3 screws. (Picture 5)
3. Attach the blade guard to the tube using Clamping bracket and two screws. (Picture 6)
4. Install gear case cover (Picture 7), blade (Picture 8), clamping plate (Picture 9), and install blade mounting bolt with washers. Left thread, rotate counter-clockwise to tighten. (Picture 10)
5. Lock the gear shaft by putting a pin provided or screwdriver through the aligned keyholes in the gear case cover and the gear case. Use a socket wrench to tighten the blade-mounting bolt. Rotate bolt counter clockwise to tighten. (Picture 11)
6. Split the bracket, install the wheel assembly to the tube, and clamp it at the position best for your job, using two screws. (Picture 12 and 13)
7. You can replace loop handle with the U-shaped handle that comes with your Edge Trimmer Attachment.

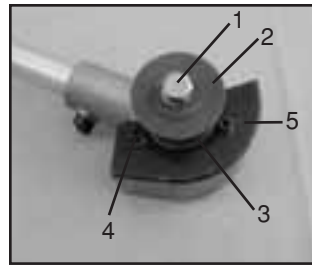

Picture 1

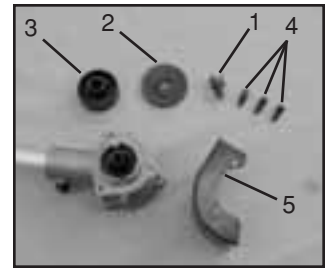

Picture 2



Picture 3



Picture 4

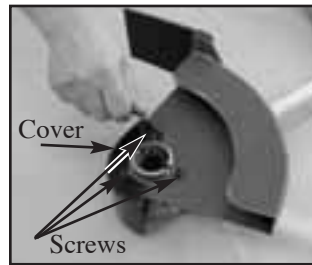

Picture 5

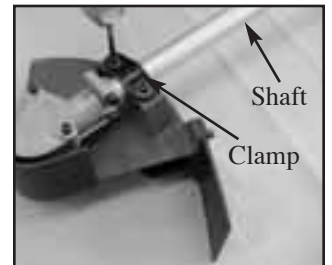

Picture 6

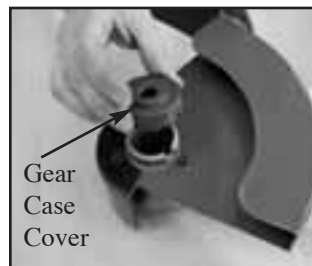

Picture 7

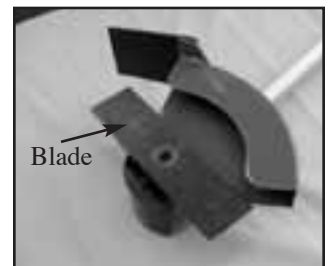

Picture 8

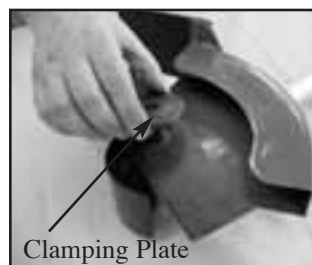

Picture 9

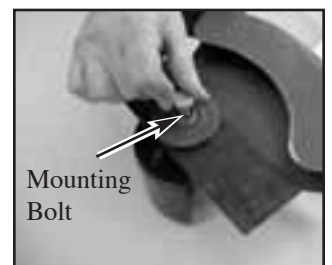

Picture 10



Picture 11

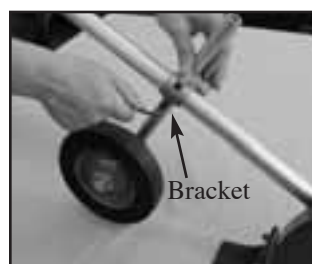

Picture 12

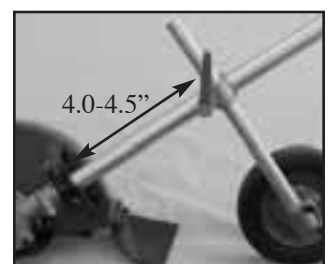

Picture 13

## Attaching the Edger to the Power Head assembly.

No tools are required to attach the Edge Trimmer to the power head assembly.

1. Pull the spring pin up on the adapter of the power head shaft assembly. (Picture 14)
2. Carefully fit edger drive shaft into adapter, making sure that male spline of the inner drive shaft engages into the female spline socket of the power head shaft.
3. When the drive shaft is properly aligned, the spring pin will drop into the hole on the shaft of the edger attachment. A click should be heard when completed.
4. Insure two shaft parts are fully engaged by twisting them.
5. Full engagement will prevent shaft rotation.
6. Secure assembly by tightening the knob. (Picture 15)



Picture 14



Picture 15

## Balancing and Depth Adjustment

Check the balance of the assembled unit. The handles and shoulder harness have been assembled at the factory and set according to the average sized person. This can be adjusted to the operator's preference.

1. Unit handles can be re-adjusted to the operator's preference by simply loosening the screws and sliding handles up or down the shaft. Re-tighten the screws (Picture 16). The distance between the replacement portion of the blade and the foremost portion of the guiding handle should be at least 18" (450mm). (Picture 17)
2. Wheel height can be re-adjusted by loosening clamp lever, and changing the height of the wheel to achieve desired cutting depth. (Picture 18) Up-deep cut, down-shallow cut.



Picture 16



Picture 17

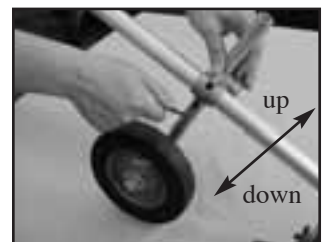

Picture 18

## Replacement Blade Installation

Tools:  $\frac{9}{16}$ " wrench, pin or screwdriver

1. Lock the gear shaft by inserting the pin or screwdriver through the aligned keyholes in the gear case cover and the gear case to prevent rotation (Picture 19).
2. Hold the pin or screwdriver in place and remove bolt by turning it clockwise (Picture 20), then remove clamping plate (Picture 21), and worn blade (Picture 22).
3. Place new blade (Picture 23), re-install clamping plate (Picture 24), and bolt (Picture 25). Use wrench to tighten the blade-mounting bolt. If bolt is worn or damaged use a new one. **Replace worn or damaged blade and bolts in sets to preserve balance.**

**⚠ WARNING – DANGER ⚠**

**BE SURE UNIT IS UNPLUGGED BEFORE  
MAKING ANY ADJUSTMENTS.**



Picture 19



Picture 20



Picture 21



Picture 22



Picture 23



Picture 24



Picture 25

## Trimming Techniques

1. With both hands on the handles, push lockout trigger button with your thumb first, and then squeeze trigger. **Start edging when blade rotates at full RPM, by lowering the blade gently into the ground.**

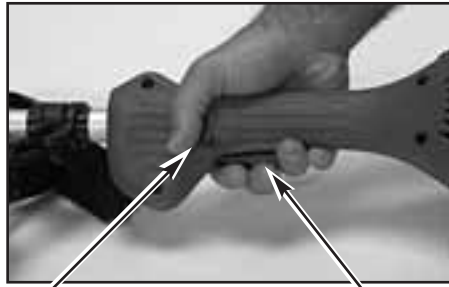

Lockout Trigger Button

Trigger

2. Thoroughly inspect the surface where the equipment is to be used and remove all stones, sticks, wires, bones and other foreign objects.
3. Before edging, water the area to soften the ground to make edging easier.
4. Plan to edge regularly to make it easier to keep a neat edge and to avoid making more than one pass.
5. Don't force the blade. Only move forward as the blade will allow.
6. Do not use Edger Attachment to make a new groove into hard ground!
7. You can use the V-notch to indicate position of the blade tip.

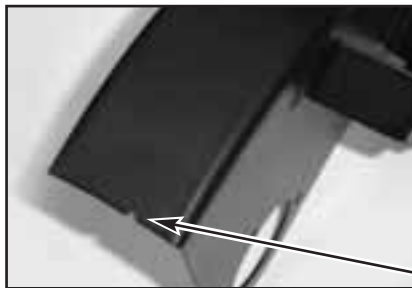

V-notch to indicate the position of the blade tip

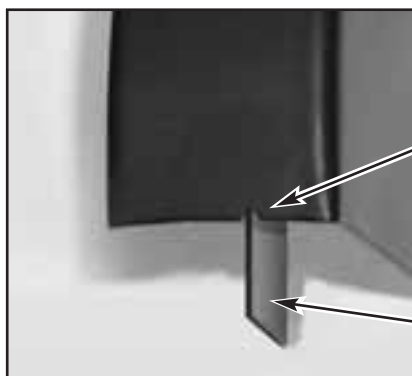

V-notch in the blade guard

Blade

## Storage

1. Clean.
2. Lubricate for rust prevention.
3. Store indoor.

## Service Maintenance Guide

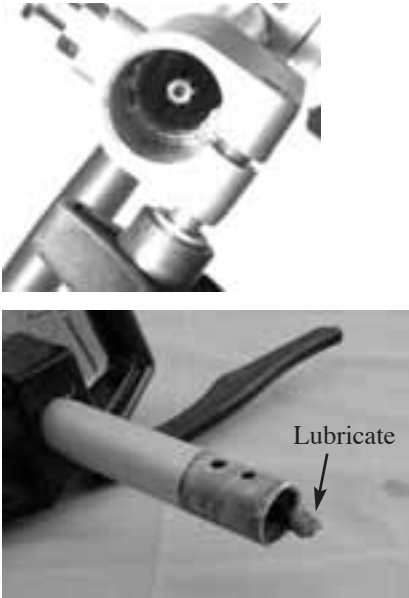
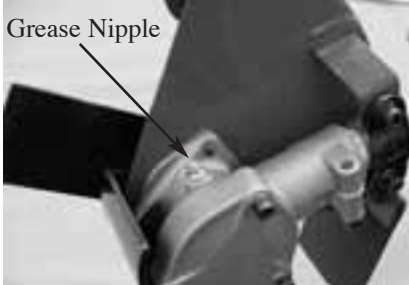
Area	Maintenance procedure	Frequency
Spline male/female connection of the inner drive shaft 	Inspect/Lubricate  1. Remove the side screw, and loosen up other three as shown on the diagram (left). 2. Pull the shaft from the gear housing. 3. Pull and clean internal shaft. 4. Lubricate. 5. Re-install the drive shaft. 6. Do not allow any dirt and dust on the internal drive shaft 7. Do not allow any dirt and dust entering into the gear case	20-25 Hrs
Gear case 	Inspect/Clean debris  Use a grease gun to insert lubricant into the grease nipple of the gear case, using EP2 lithium grease. Do not overfill! Remove the gear case cover, and clamping plate before inserting new grease to arrange for old grease to exit Do not allow any dirt and dust entering into the gear case	20-25 Hrs
Screws/Nuts/Bolts	Inspect/Tighten/Replace	Before each use
Blade	Inspect/Clean/Replace	Before each use

Area	Maintenance	Before Use	Every 25 Hours	Every 50 Hours	Every 100 Hours	Note
Cutting Parts	Replace if something is wrong	✓				
Screws, nuts bolts	Tighten, replace	✓			✓	Not adjusting screws
Blades	Oiling	✓				Light #10 oil

**IMPORTANT:** Time intervals shown are maximum. Actual use and your experience will determine the frequency of required maintenance.

# Edger "E" System Exploded View

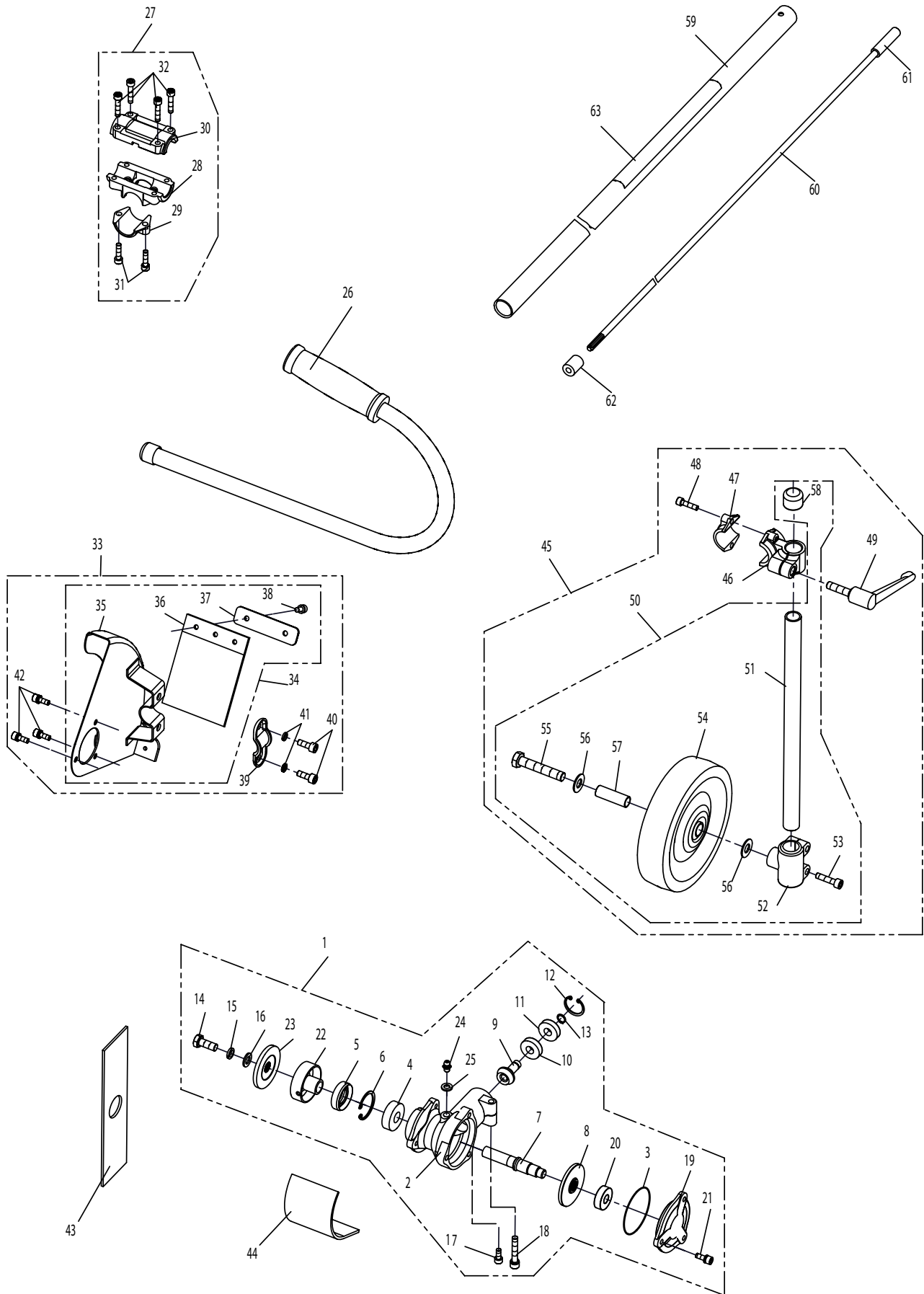

## Edger “E” System Parts List

KEY #	DESCRIPTION	PART #	QTY	KEY #	DESCRIPTION	PART #	QTY
1	GEAR CASE ASSEMBLY	331137	1	33	GUARD WITH CLAMP ASS'Y	331160	1
2	GEAR CASE	331138	1	34	BLADE GUARD ASSEMBLY	331161	1
3	O-RING	331139	1	35	GUARD METAL	331162	1
4	BEARING 6201Z	331140	1	36	RUBBER DEBRIS GUARD	331163	1
5	SEAL	331141	1	37	GUARD CLAMPING PLATE	331164	1
6	RING RETAINING	331142	1	38	BOLT M5X12	331519	2
7	SHAFT	331143	1	39	GUARD CLAMP	331165	1
8	GEAR	331144	1	40	BOLT M6X16	331520	2
9	PINION	331145	1	41	WASHER	331521	2
10	BEARING 609	331146	1	42	BOLT M5X14	331515	3
11	BEARING 609Z	331147	1	43	BLADE	331166	1
12	RING RETAINING	331148	1	44	COVER	331167	1
13	RING RETAINING	331149	1	45	WHEEL ASS'Y WITH ADAPTER	331168	1
14	MOUNTING BOLT	331510	1	46	ADAPTER		
15	LOCK WASHER	331511	1		(WHEEL TO MAIN SHAFT)	331169	1
16	FLAT WASHER	331512	1	47	CLAMPING BRACKET HALF	331170	1
17	BOLT M5X12	331513	1	48	BOLT M5X20	331517	2
18	BOLT M6X35	331514	1	49	LEVER	331171	1
19	COVER	331150	1	50	WHEEL ASS'Y	331172	1
20	BEARING	331151	1	51	WHEEL SHAFT	331173	1
21	BOLT M5X14	331515	3	52	WHEEL BRACKET	331174	1
22	GEAR CASE COVER	331152	1	53	BOLT M6X25	331522	2
23	CLAMPING PLATE	331153	1	54	WHEEL	331175	1
24	GREASE FITTING	331154	1	55	WHEEL BOLT	331523	1
25	WASHER	331516	1	56	FLAT WASHER	331524	2
26	U-HANDLE SUB ASSEMBLY	331155	1	57	SLEEVE	331176	1
27	BRACKET- ASS'Y	331156	1	58	CAP	331181	1
28	ADAPTER			59	OUTER SHAFT 024X623MM	331182	1
	(HANDLE TO MAIN SHAFT)	331157	1	60	INTERNAL SHAFT 628X7NH	331183	1
29	BRACKET 1/2 (SHAFT)	331158	1	61	INTERNAL SHAFT ADAPTER	331184	1
30	BRACKET 1/2 (U-HANDLE)	331159	1	62	SPACER	331185	1
31	BOLT M5X20	331517	2	63	WARNING LABEL	331180	1
32	BOLT M5X25	331518	4				

**2 YEAR LIMITED SERVICE & WARRANTY POLICY  
FOR ELECTRIC EDGER ATTACHMENT**

MANTIS extends this limited warranty against defects in material and workmanship for a period of two years from the date of purchase, to the first retail purchaser and each subsequent owner during the warranty period. This warranty covers all portions of the Mantis Electric Edger Attachment.

MANTIS will repair or replace, at its option, any part or parts of the product proven to be defective in material or workmanship under normal usage during the warranty period. Warranty repairs and replacements will be made without charge for parts or labor. All parts replaced under warranty will be considered as part of the original product, and any warranty on the replaced parts will expire coincident with the original product warranty. In the event of a defect or malfunction, the purchaser must send the product, postage paid to:

Mantis  
2800 Turnpike Dr.  
Suite #1  
2800 Commerce Center  
Hatboro, PA 19040

MANTIS assumes no responsibility in the event that the product was assembled or used in noncompliance with any assembly, care, safety, or operating instructions contained in the Owner's Manual; was not used with reasonable care; or was misused, used for other than normal or intended purposes. This warranty does not extend to parts affected or damaged by normal wear and tear.

MANTIS MAKES NO EXPRESS OR IMPLIED WARRANTIES OR REPRESENTATIONS EXCEPT THOSE CONTAINED HEREIN. THE DURATION OF ANY IMPLIED WARRANTY, INCLUDING MERCHANTABILITY AND FITNESS FOR A PARTICULAR PURPOSE, IS LIMITED TO THE DURATION OF THIS WRITTEN LIMITED WARRANTY. MANTIS DISCLAIMS ALL LIABILITY FOR INDIRECT AND/OR CONSEQUENTIAL DAMAGES. SOME STATES DO NOT ALLOW LIMITATIONS ON HOW LONG AN IMPLIED WARRANTY LASTS AND/OR DO NOT ALLOW THE EXCLUSION OR LIMITATION OF INCIDENTAL OR CONSEQUENTIAL DAMAGES, SO THAT ABOVE LIMITATIONS AND EXCLUSIONS MAY NOT APPLY TO YOU. THIS WARRANTY GIVES YOU SPECIFIC LEGAL RIGHTS, AND YOU MAY ALSO HAVE OTHER RIGHTS WHICH VARY FROM STATE TO STATE.

**MANTIS**  
**1028 Street Road**  
**Southampton , PA 18966**  
**(215) 355-9700**